

DSP-DGFR

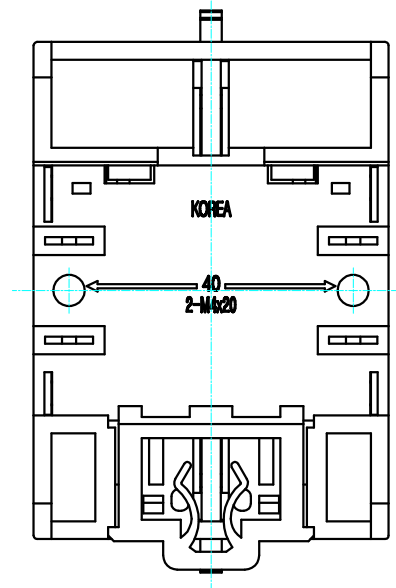
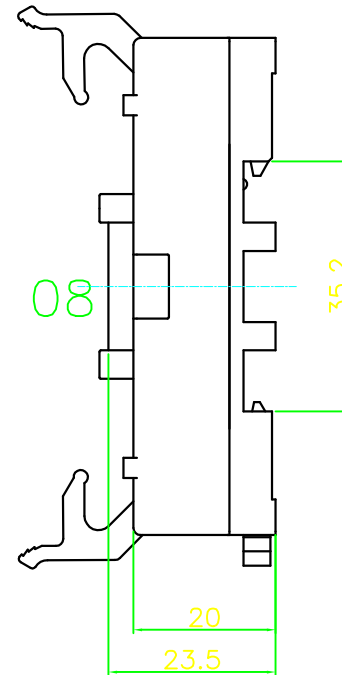
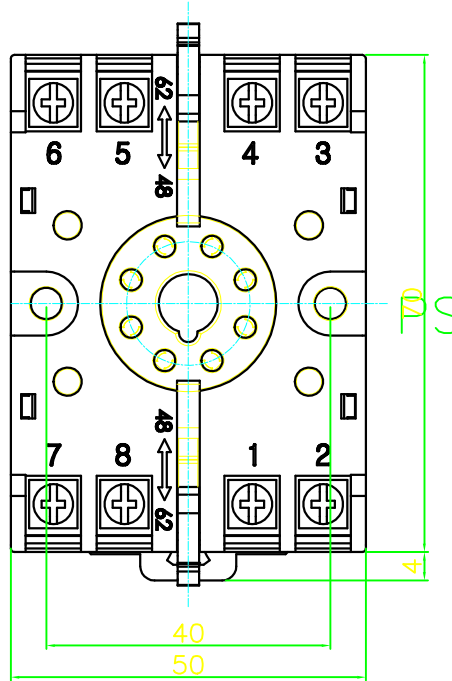
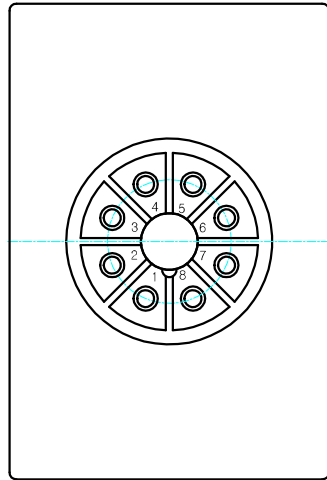
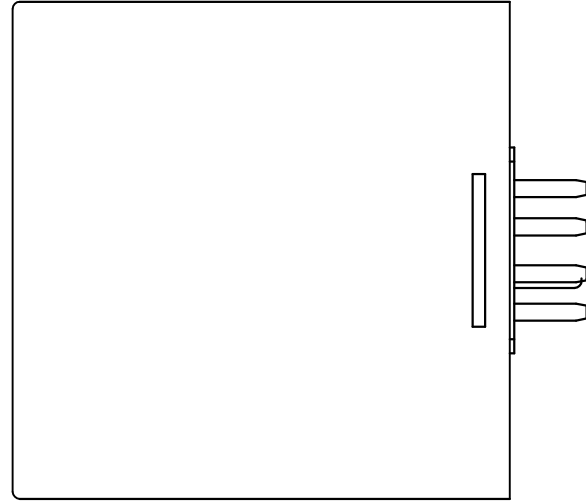
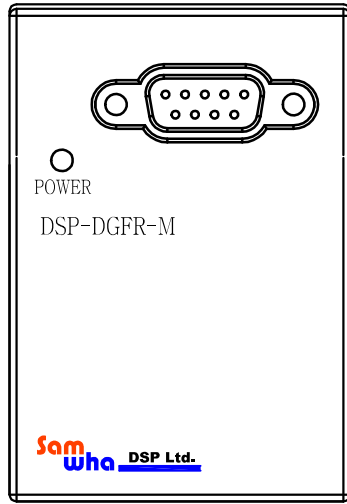

④					
③					
②					
①					
REV'No	DATE	DESCRIPTION	DR'N	CH'D	APP'D

PROJECT	
TITLE	DSP-DGFR

DR'N BY	CH'D BY	APP'D BY	SCALE	WORK No.	CAD FILE NAME	SHEET No.
			1/NS		SAMPLE	/
			DRAWING No.		REV' No.	
Sam Who DSP Ltd.			삼화DSP 주식회사		20 - 1019 - 003	

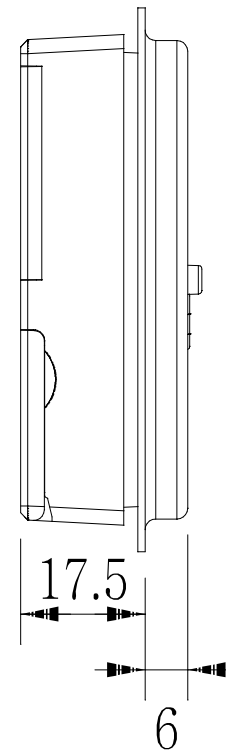
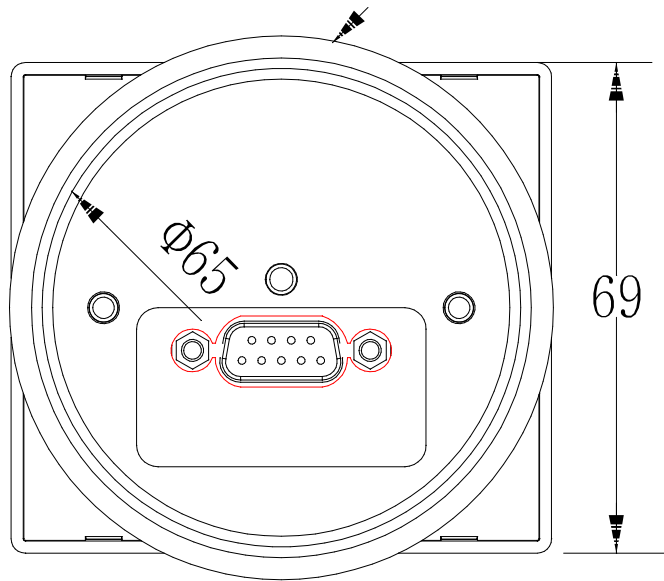
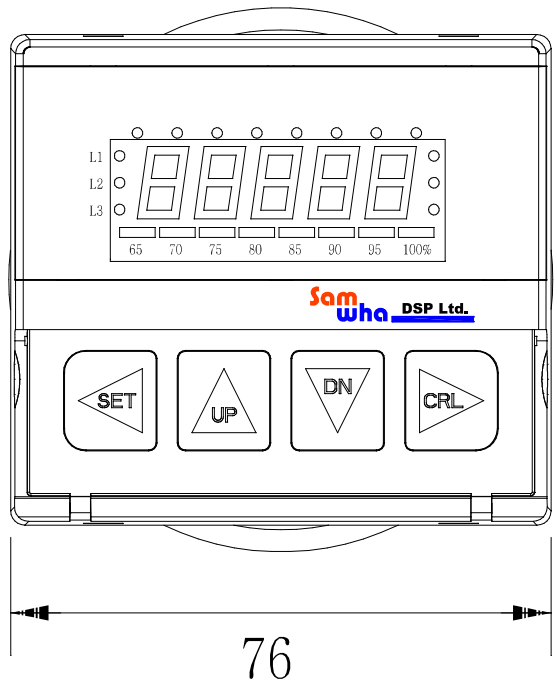

4						PROJECT	DR'N BY	CH'D BY	APP'D BY	SCALE	WORK No.	CAD FILE NAME	SHEET No.
3						TITLE DSP-DGFR				1/NS		SAMPLE	/
2										DRAWING No.		REV' No.	
1										20-1019-003			
REV'No	DATE	DESCRIPTION	DR'N	CH'D	APP'D		Sam Who DSP Ltd.		삼화DSP 주식회사				